

Sainellor

Mini Family & Outdoor Projector

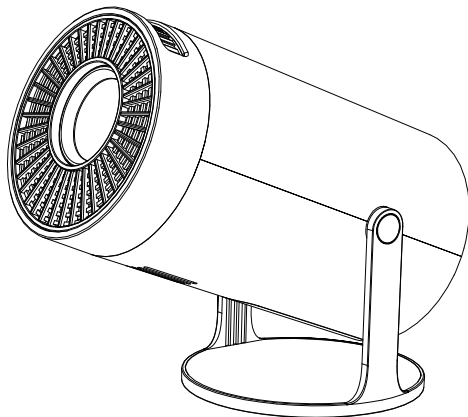

USER MANUAL

BEGINNING WORDS

First of all, thank you for your support!

You can fully understand the use and operation of this product by reading this manual.

This hand-held projection equipment is small, portable and powerful, which is specially designed for household, entertainment, business and other application environments. It allows you to enjoy the fun of large screen display anytime and anywhere, and you are welcome to share the fun and ideas of using it with us.

If you have any questions about this product, welcome to contact our professional after-sales service personnel, we will provide you with cordial service.

CAUTION ⚠

To prevent electronic shock, please do not open the housing. There's no parts can be repaired inside by customer. Please ask for professional staff if repairing is needed.

WARNING ⚠

To prevent fire or electronic shock, please do not put the device into rain water or humidity.

Warning: In a residential environment, running this device may cause Radio jamming.

IMPORTANT SAFETY PRECAUTIONS

Important: In order to get the best viewing effect, it's suggested that you use the product in a dark room.

Warning: Following safety instructions can sustain product's lifespan and prevent it from firing or electric shock, so please read them carefully and pay attention to all warnings.

- Do not install it in a place with poor ventilation.
- Do not install it in a hot or damp place.
- Do not block its ventilation holes (Intake or Exhaust).
- Do not install it in a dusty or smoky place.
- Do not install it near to the temperature/smoke sensor.
- Do not install it in a position directly blown by air condition.

Otherwise it might be malfunctioned because of the water & vapour condensation or high temperature.

ATTENTION:

In order to maintain the performance and reliability of the projector, please leave at least 30cm of space around the projector.

PACKING LIST

Note: Please check whether the accessories are complete after opening the package. If it's not complete, please contact customer service for a replacement.

Package Include:

① Projector x 1

② Power Cable x 1

③ HDMI Cable x 1

④ Remote Control x 1

⑤ User Manual x 1

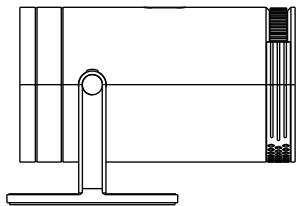

①



②

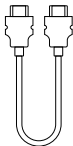

③

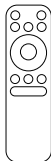

④

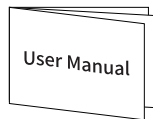

⑤

PRODUCT INTRODUCTION

PRODUCT STRUCTURE

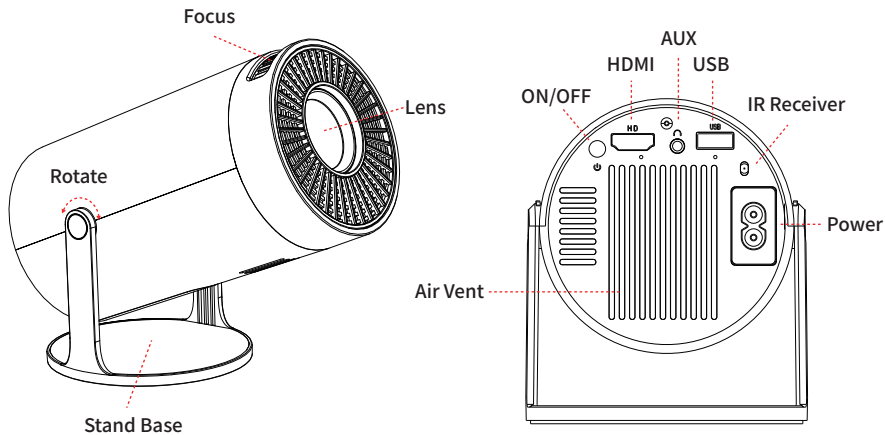

ATTENTION:

- ① Do not cover the air outlet when using, so as to avoid equipment damage caused by overheating of the device.
- ② Please click the ON/OFF button on the projector OR the power on button on the remote to turn on the projector after insert the power cable firmly.

REMOTE CONTROL

- | | |
|--------------|-----------|
| ① ON/OFF | ⑧ Mute |
| ② Backward | ⑨ Forward |
| ③ Play/Pause | ⑩ Up |
| ④ Left | ⑪ Right |
| ⑤ OK | ⑫ Down |
| ⑥ Return | ⑬ Source |
| ⑦ Volume- | ⑭ Menu |
| | ⑮ Volume+ |

NOTE:

Please install 2 AAA batteries before using, and then aim at the infrared receiving window of the device to operate the remote control. Be cautious when using the remote control.

- ① Do not drop it, trample on it, or spill any liquid into its body.
- ② Do not put the remote control near to any heat source.
- ③ Do not expose the remote control under sunlight.
- ④ Do not put the remote control in a damp place.

INSTALLATION AND DEBUGGING

1. Projector Installation

Method 1: Put it horizontally

Method 2: Hang it with ceiling mount

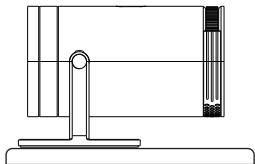

Note:

When the projector is hung on the ceiling or in a system of rear projection, please change the projection mode accordingly.

2. Projection Modes

Go to **Menu > Settings > Option > Flip** to change the projection modes per your needs.

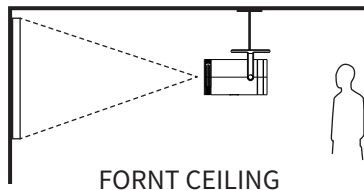
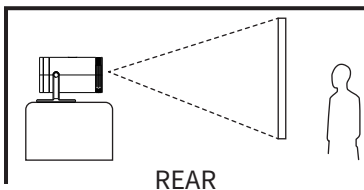
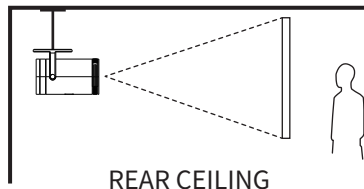
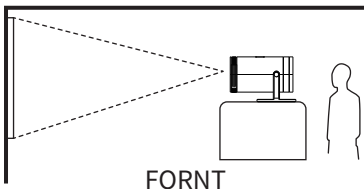

3. Focus Adjustment

When the image is blurred, it's recommended to **manually adjust** the focus to improve the clarity of the image via rotating the focus wheel on the projector. If you cannot obtain satisfactory clarity through adjustment, please move the projector forward or backward.

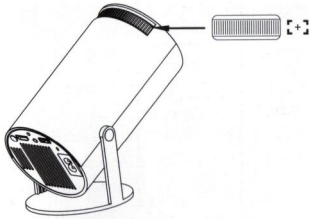

4. Electric Keystone Correction

When trapezoidal distortion occurs, the user needs to adjust the electronic keystone correction under the following Settings: **Menu > Settings > Keystone > +/-** to get a horizontal projection image.

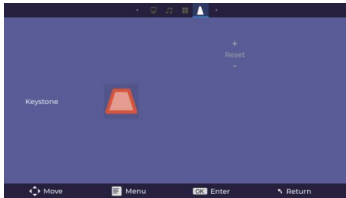

* Note on Keystone Correction:

When adjusting the keystone correction to a significant degree, you may notice that the edges of the projected image appear jagged or exhibit a "staircase" effect. This phenomenon, known as aliasing, occurs because the image is being digitally stretched or compressed to compensate for the angle of projection. To minimize this effect, we recommend positioning the projector as level as possible with the projection surface and keeping the keystone correction adjustments within a moderate range.

5. Projection Distance Reference

Projection Display Size(Inch)	36	72	108	144	200
Projection Distance (Meter)	1	2	3	4	5

Note:

Optimum **Projection Distance: 2.5m-3.5M**. **Dark environment** will improve the clarity and sharpness of the projection picture.

6. Air Inlet Dust Removal

In order to provide a better projection effect and avoid dirt spot on projection image, please keep the projection air inlet and outlet unobstructed. Stay away from dust to the projector.

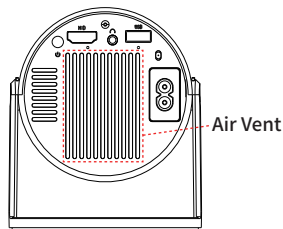

7. Turn Off Safely

Press the power button on operation panel or remote control, and turn off the device according to the system prompts.

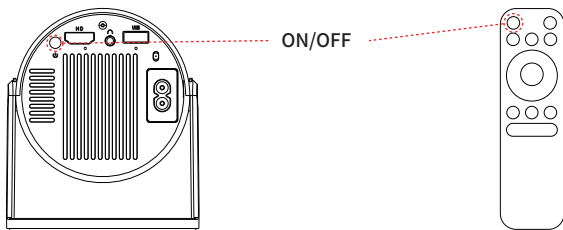

MULTI-MEDIA CONNECTION

HDMI Connection

STEP 1: Connect your HDMI devices to the projector with HDMI Cable.

HDMI Compatible Devices: Laptop, TV Stick, PS4, XBOX, DVD Player, etc.



1



2



3

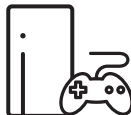

4



5

STEP 2: Choose "HDMI" in home page OR Press the "Source" button on the remote control to select HDMI as the input source.

Sound Settings for HDMI Connections

① Turn off Dolby audio in your device (such as TV stick/PS4/PS5).

- ② If there is no sound with Blu-ray Disc Player, please change the sound model to PCM in your DVD player.
- ③ If there is no sound with Cable Box, change the sound model to PCM in your Cable Box.
- ④ If there is no sound with a USB stick/TF card, please don't download the video with Dolby(AC3).
- ⑤ If there is no sound with the Laptop/Mac-book via HDMI connection, please change the laptops sound output to HDMI under Setting-sound-select HDMI as the sound output device.

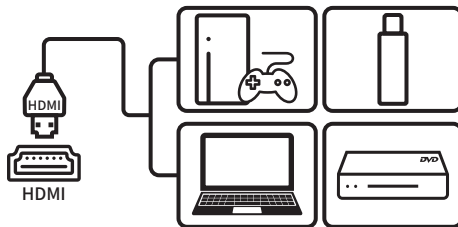
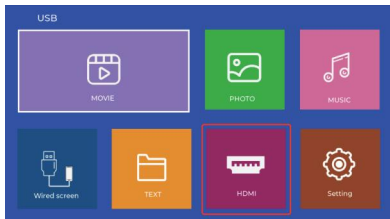

USB Connection - Local Media Play

STEP 1: Connect the USB flash driver to the projector and select "Media" as the input source.

STEP 2: Select local disk [USB flash driver] to select (videos, pictures, musics and all files)

STEP 3: Press OK to play; press the return key to exit.

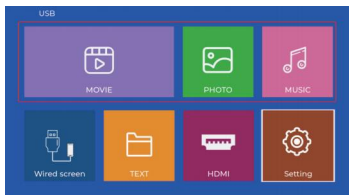

● USB/TF Unrecognized

1. Make sure your USB stick/TF card is **not over 32GB**;
2. You can format the USB stick to FAT 32 or NTFS.

Local Player support format as following:

Video	MP4, AVI, MOV, MKV, FLV, MPG, TS, 3GP, VOB
Audio	AAC, AMR, FLAC, M4A, MP2, MPGA, OGG, WAV
Picture	JPEG, BMP, PNG, JNG

Wired Screen Connection

IOS WIRED DISPLAY

STEP 1: Turn on the projector and choose [Wired screen] as signal source.

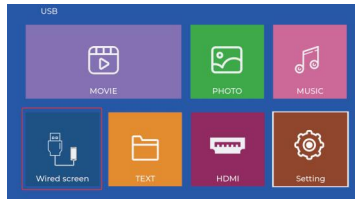

Quick Screen Mirroring Guide

For Android devices:

- Need to download the screen mirroring APP:
- 📲 Scan the QR code and tap [Get It on Google Play] to download.
- 📲 Or search [Vision Pass] on Google Play to download directly.



For iPhone/iPad:

- No download needed.
- 📲 Lightning models: Connect with the original USB cable.
- 📲 Type-C models: You may use a USB-C to HDMI cable → Select [HDMI] input.

STEP 2: Connect your iOS device with projector's USB port via USB cable; click "Trust" then put your Lock screen password; then the connection is succeeded.

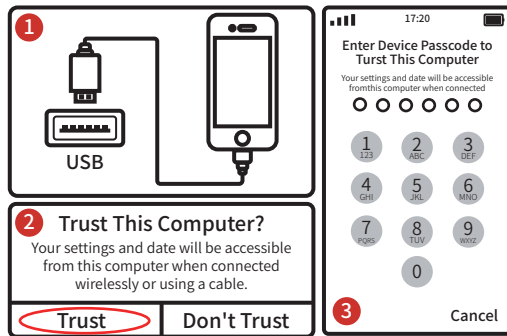

Attention: Due to the copyright of the Prime Video, Netflix, iTunes, Hulu, you can't play these APPS via phone mirroring connection. Please note nearly 99% of projectors on the market can't play these APPS. You can play those APPS by Laptop or TV Stick via HDMI Connections.

Important Notes for iPhone Wired Connection

① iOS Compatibility Notice

iOS devices update their software automatically. If you're unable to use screen mirroring, please contact us. We'll provide the latest compatible firmware for your projector.

② For iPhones with Lightning Ports (iPhone 12 and earlier models)

If your iPhone uses a Lightning to USB-C charging cable, you'll need a separate genuine **Lightning to USB cable** to connect it to the projector.

③ For iPhones with USB-C Ports (iPhone 15/16 and later models)

These devices use a USB-C to USB-C cable by default. To connect to the projector, use a separate **USB-C to HDMI cable**. After connecting, select "HDMI" on the projector's home screen.

Need a conversion cable?

If you don't have the required adapter cable mentioned above, please contact us and we'll arrange one for you as soon as possible.

ANDROID WIRED DISPLAY

STEP 1: Turn on the projector and Choose **[Wired screen]** as signal source.

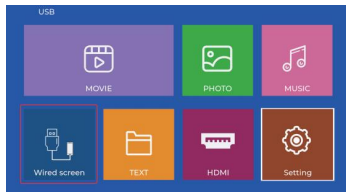

STEP 2: Scan the **QR Code** on the projector screen by your smartphone and install the mirroring APP on your smartphone.

STEP 3: Connect your android device with projector's USB port via USB cable; then the connection is succeed.

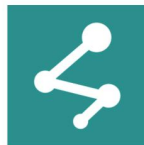

Vision Pass
Transsion Holdings

Recommend scanning the code and clicking **[get it on Google Play]** or directly searching for **[Vision Pass]** to download

*Sound Comes Out from Smartphone After Screen Mirroring:

- **Attention:** Due to different brand's Android Smartphone copyright and user agreement, some Android device can only screen mirroring the picture and videos while the sound comes out from the phone.
- **Solution:** You can connect your smartphone to your Wired Speaker while screen mirroring. Then the picture will play on the projector and the sound will come out from your Bluetooth Speaker. You will enjoy a cinematic audio and visual experience by doing this.

Devices not supported by Android: Sony Xperia, Sharp AQUOS, and Google Pixel series.

PROJECTOR SETTINGS

1. System Settings

Click "Menu" Button, and click "Left/Right" Button to "OPTION", then adjust the "OSD Language" / "Projection Mode" / "Factory Reset" / "Software Upgrade" / "Auto Sleep" / "OSD Timer" / and "Version" according to your needs.



◆ Language

Go to **Settings > Option > OSD Language**, press "OK" to enter language option to choose language.

◆ Projection Mode

Go to **Settings > Option > Flip** to change the Projection Mode per your needs.

◆ Factory Reset

Go to **Settings > Option > Factory Reset** to reset factory data.

◆ Software Upgrade

Go to **Settings > Option > Software Upgrade** to update your internal system to the latest version.

◆ Auto Sleep

Go to **Settings > Option > Auto Sleep** to set up the auto sleep time from 3 hours to 5 hours. The auto sleep feature is valuable for managing power consumption and ensuring the longevity of electronic devices.

◆ OSD Timer

Go to **Settings > Option > OSD Timer**. The OSD Timer allows users to set the duration for which the on-screen menu is displayed. For instance, you might set it to 5 seconds, 10 seconds, or even longer. After this set period, if no further action is taken, the menu will automatically disappear from the screen and go to the home page.

2.Sound Settings

Click "Menu" Button, and click "Left/Right" Button to "**SOUND**"; then adjust the "Sound Mode"/ "Treble"/"Bass"/ and "Balance" according to your needs.

- Set up sound patterns of standard, music, movie, sports and user under sound mode.
- Balance is to balance the sound of the left and right channel of the speaker.

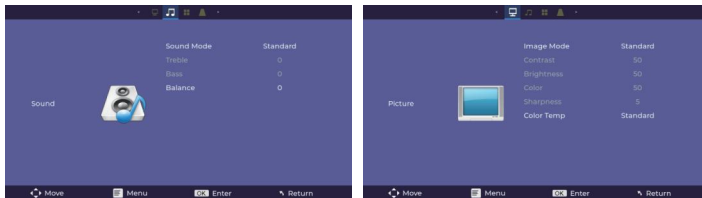

3. Picture Settings

Click "Menu" Button, and click "Left/Right" Button to "PICTURE"; then adjust the "Picture Mode"/"Contrast"/"BrighENess"/ "Color"/ "Sharpness"/ and "Color Temperature" according to your needs.

WARM TIPS:

Switch color temperature to Medium, Warm, User and Cool to meet different usage. "Warm Mode" is good for movies and "Cool Mode" is great for image display.

SPECIFICATIONS

Product Name	F300 Projector	Display Technology	LCD
Light Source	LED	Focus Adjustment	Manual Focus
Keystone Adjustment	Electric Keystone	Display Resolution	1920x1080P
Screen Ratio	4:3/16:9	LED Lamp Life	50,000 Hours
Projection Mode	Front/Rear/Front Ceiling/Rear Ceiling	Contrast Ratio	20000:1
Projection Size	30-300 Inch	Projection Distance	1-5 Meters
Speaker	3W x 2	Audio File	WMA/MP3/M4A(AAC)
Picture File	JPEG/BMP/PNG	Video File	MPEG1/MPEG2/MPEG4/RM/AVI/RMVB/MOV/MKV/DIVX/VOB/M-JPEG
Output	AUX	Power Voltage	AC 100V-240V, 40W, 50/60Hz, 1.1A
Input	HDMI/USB		
*Specifications and designs are subject to change without notice.			

IMPORTANT FAQ

➤ Blurry Image

1. Adjust the focus and projection distance slowly to get it clear.
2. The projection size is 30-100inch with projection distance 0.7M--3M.
3. It is recommended to use in a dark environment.
4. It is a mini portable projector for movie nights, not recommended for text or PPT.
5. The projector is small and light, it really is a good value for the price, as it was so inexpensive.
6. If you have problem, please find the manufacturer customer support, the problem will be solved within 12 working hours.

➤ USB/TF Unrecognized

1. Make sure your USB stick/TF card is not over 32GB.
2. You can format the USB stick to FAT32 or NTFS.

➤ Fan loud

The fan needs to be turned faster to cool the heat, as the projector is small, the fan may make some noise but its tolerable. If you want to have better movie sound, you can connect an external speaker. If still has problem, please contact the customer support, the problem will be solved within 12 working hours.

➤ Connect With External Speaker

1. Connect the External speaker to the projectors headphone port via Aux cable.
2. If you have a Bluetooth transmitter, connect Bluetooth transmitter (TX) to the projector, then open your Bluetooth speaker, the sound will come from the Bluetooth speaker.
3. If you use a fire TV stick usually you can connect the Bluetooth speaker with the TV stick, then the sound will come from the Bluetooth speaker.

➤ No Sound

1. Turn off Dolby audio in your device (such as TV stick).
2. If there is no sound with Blu-ray Disc Player, please try with another HDMI cable or change the sound model to PCM in your DVD player.
3. If there is no sound with Cable Box, please change the sound model to PCN in your Cable Box.

4. If there is no sound with a USB stick / TF card, please don't download the video with Dolby (AC3).
5. If there is no sound with the laptop via HDMI connection, please change the laptops sound output device (setting-sound-select sound output device). If it still has no sound, please change another HDMI cable.

➤ Overheat

1. The high temperature around the environment may cause the projector be heater than normal. For example, if the temperature is high in summer ,please don't use it outside at that time.
2. The projector shall be stored far from any heat including heater, heat register and other heat generation devices.
3. If the bottom of the projector still has a little heater, please don't worry ,the machine has a good heat dissipation system and these will not affect the projector and it is safe.
4. For this small and portable model, we have been working on technical improvements in temperature technology. If you have any questions about the temperature, you can contact us. We will solve the problem within 12 working hours.

➤ Connect With laptop

1. If your laptop has a native HDMI port, you can use a HDMI cable to connect it to the projectors HDMI port.

2. If your laptop doesn't have a native HDMI port, you need to use a USB-C adapter or Mini DP to HDMI adapter.

➤ Play Netflix, Prime Video, Hulu

1. You can enjoy Prime Video, Netflix, iTunes, Hulu and other videos via TV BOX, such as using a Roku or Fire TV Stick.
2. You also can enjoy them from a laptop via HDMI connection to the projector.
3. As the copyright says, you can't play them from your phone via USB connection.

➤ Connect With Phone

Due to the copyright of the Prime Video, Netflix, iTunes, Hulu, you can't play these APPS via phone connection. Please note nearly 99% of projectors on the market can't these APPS. You can play those APPS via TV Stick or Laptop.

➤ Contact Customer Support

If you have other problems, please contact the seller at Sainellor@163.com, your problem will be solved within 12 working hours.

Warranty

30-Day Money-Back Guarantee for Any Reason

You may return your undamaged product and packaging within 30 days of purchase to receive a FULL REFUND for any reason. If the reason for return isn't quality-related, the customer must pay for the return shipping.

12-Month Warranty for Quality-Related Issues

Sainellor products are warrantied to be free from material and workmanship defects for 12 months from the date of purchase. Within this period, Sainellor will provide a replacement for products that fail in normal use.

Contact us

If you encounter any problems during use, please don't hesitate to contact us for professional help! We are not satisfied until you are 100% satisfied.